

Bill's

# ACE Truckbox Center

TRUCKS, VANS & JOBSITES



**WE ARE THE  
LARGEST**

**weather guard**

**KNAACK**

**STOCKING  
DEALER  
in the USA!**

**PROFESSIONAL  
INSTALLATION  
AVAILABLE!**

*...shop where the pros shop*

[www.acetruckbox.com](http://www.acetruckbox.com)

Toll Free 888-379-0828

# Bill's ACE Truckbox Center

TRUCKS, VANS & JOBSITES

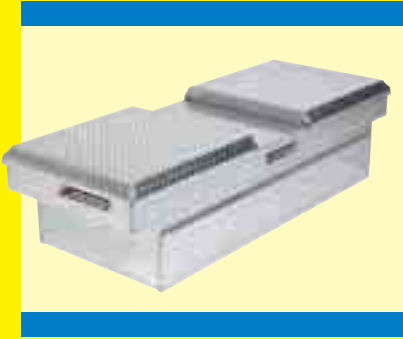

**BOXES**  
PAGE 3-9



**VAN ACCESSORIES**  
PAGE 10-15



**LIQUID TRANSFER TANKS**  
PAGE 16-17



**TRUCK RACKS**  
PAGE 18-19



**HITCHES & ACCESSORIES**  
PAGE 20-26



**TRUCK ACCESSORIES**  
PAGE 27-31



**JOBSITE BOXES**  
PAGE 32-35

- VOLUME DISCOUNTS AVAILABLE •
- WHOLESALE/DEALER PRICING AVAILABLE •

**LARGEST IN-STOCK  
KNAACK/WEATHERGUARD DEALER**

**CALL FOR DETAILS**  
TOLL FREE 888-379-0828



Model 126-3-01

Model 125-3-01



Model 175-3-01



Model 166-3-01

**PLEASE CALL FOR CURRENT PRICES**



Model 665-3-01



Model 264-3-01



**REPLACEMENT GAS SHOCKS & LATCHES IN-STOCK**

**STEEL SADDLE BOXES**

SIZE	MODEL	CU. FT.
FULL SIZE X-WIDE	116-3-01*	15.3
FULL SIZE X-DEEP	128-3-01*	15.1
FULL SIZE STANDARD	126-3-01*	11.3
COMPACT DEEP	136-3-01*	8.9
COMPACT STANDARD	156-3-01*	6.5

**STEEL CROSSBOXES - DUAL LID**

SIZE	MODEL	CU. FT.
FULL SIZE X-WIDE	115-3-01	15.3
FULL SIZE STANDARD	125-3-01*	11.3

**STEEL LO-SIDE BOXES**

SIZE	MODEL	CU. FT.
LONG	165-3-01	6.2
STANDARD	175-3-01	4.5
SHORT	185-3-01	3.2

**STEEL SUPER-LO SIDE BOXES**

SIZE	MODEL	CU. FT.
LONG X-WIDE/DEEP	166-3-01	9.2
STANDARD X-WIDE/DEEP	176-3-01*	6.5
SHORT X-WIDE/DEEP	186-3-01	4.5

**STEEL ALL-PURPOSE CHESTS**

SIZE	MODEL	CU. FT.
COMPACT	645-3-01*	6.0
FULL/COMPACT	655-3-01	12.0
FULL SIZE STANDARD	665-3-01*	13.1
FULL/COMPACT	675-3-01	10.0
FULL SIZE X-WIDE	685-3-01	18.6

**STEEL SUPER SIDE BOXES**

L	W	H	MODEL	CU. FT.
45 <sup>5</sup> / <sub>8</sub> "	15 <sup>1</sup> / <sub>8</sub> "	18"	247-3-01	7.0
64 <sup>1</sup> / <sub>8</sub> "	15 <sup>1</sup> / <sub>8</sub> "	18"	265-3-01	10.0
90 <sup>1</sup> / <sub>8</sub> "	15 <sup>1</sup> / <sub>8</sub> "	18"	291-3-01	14.0

**STEEL HI-SIDE BOXES**

L	W	H	MODEL	CU. FT.
45 <sup>5</sup> / <sub>8</sub> "	12 <sup>3</sup> / <sub>8</sub> "	16"	246-3-01	5.16
64 <sup>1</sup> / <sub>8</sub> "	12 <sup>3</sup> / <sub>8</sub> "	16"	264-3-01	7.26
72 <sup>1</sup> / <sub>8</sub> "	12 <sup>3</sup> / <sub>8</sub> "	16"	272-3-01	8.16
90 <sup>1</sup> / <sub>8</sub> "	12 <sup>3</sup> / <sub>8</sub> "	16"	290-3-01 *	10.21
96 <sup>1</sup> / <sub>8</sub> "	12 <sup>3</sup> / <sub>8</sub> "	16"	296-3-01	10.89

**STEEL JUMBO SUPER-SIDE BOX**

L	W	H	MODEL	CU. FT.
96 <sup>1</sup> / <sub>8</sub> "	15 <sup>7</sup> / <sub>8</sub> "	24"	297-3-01	21.0

\* ALSO AVAILABLE IN BLACK



## ALUMINUM SADDLE BOXES

SIZE	MODEL	CU. FT.
FULL SIZE X-WIDE	117-0-01 *	15.3
FULL SIZE X-DEEP	123-0-01 *	15.1
FULL SIZE STANDARD	127-0-01 *	11.3
FULL SIZE DEEP	137-0-01 *	8.9
FULL SIZE STANDARD	147-0-01 *	10.6
FULL SIZE LOW-PROFILE	121-0-01 *	8.8
COMPACT STANDARD	154-0-01 *	6.4
COMPACT LOW-PROFILE	131-0-01 *	8.7

## ALUMINUM DUAL-LID CROSS BOXES

SIZE	MODEL	CU. FT.
FULL SIZE X-WIDE	114-0-01 *	15.5
FULL SIZE STANDARD	124-0-01 *	11.3

## ALUMINUM LO-SIDE BOXES

SIZE	MODEL	CU. FT.
LONG	164-0-01 *	6.4
STANDARD	174-0-01 *	4.1
SHORT	184-0-01 *	3.4

## ALUMINUM ALL-PURPOSE CHESTS

SIZE	MODEL	CU. FT.
COMPACT	644-0-01 *	6.0
FULL/COMPACT	654-0-01 *	12.0
FULL SIZE STANDARD	664-0-01 *	13.1
FULL/COMPACT	674-0-01 *	10.0
FULL SIZE X-WIDE	684-0-01 *	18.6

## ALUMINUM HI-SIDE BOXES

L	W	H	MODEL	CU. FT.
45 <sup>5</sup> / <sub>8</sub> "	13"	16"	346 *	5.3
64 <sup>1</sup> / <sub>8</sub> "	13"	16"	364 *	7.6
72 <sup>1</sup> / <sub>8</sub> "	13"	16"	372 *	8.7
90 <sup>1</sup> / <sub>8</sub> "	13"	16"	390 *	10.8
96 <sup>1</sup> / <sub>8</sub> "	13"	16"	396 *	11.5
45 <sup>5</sup> / <sub>8</sub> "	16"	18"	347 *	7.6
64 <sup>1</sup> / <sub>8</sub> "	16"	18"	365 *	10.7

## ALUMINUM JUMBO SUPER-SIDE BOX

L	W	H	MODEL	CU. FT.
90 <sup>1</sup> / <sub>8</sub> "	16"	18"	391 *	14.9

## ALUMINUM UNDERBED BOXES

L	W	H	MODEL	CU. FT.
24 <sup>1</sup> / <sub>8</sub> "	12 <sup>1</sup> / <sub>4</sub> "	14"	622 *	2.4
24 <sup>1</sup> / <sub>8</sub> "	24"	24"	626 *	8.0
24 <sup>1</sup> / <sub>8</sub> "	18"	18"	627 *	4.3
30 <sup>1</sup> / <sub>8</sub> "	18"	18"	631 *	5.4
30 <sup>1</sup> / <sub>8</sub> "	24"	24"	632 *	10.0
36 <sup>5</sup> / <sub>8</sub> "	18"	18"	636 *	6.5
36 <sup>5</sup> / <sub>8</sub> "	24"	24"	638 *	12.2
48 <sup>1</sup> / <sub>8</sub> "	18"	18"	648 *	8.6
48 <sup>1</sup> / <sub>8</sub> "	24"	24"	650 *	16.0
60 <sup>1</sup> / <sub>8</sub> "	18"	18"	660 *	11.2
60 <sup>1</sup> / <sub>8</sub> "	24"	24"	662 *	20.0

\* ALSO AVAILABLE IN BLACK



Model 121-1-01



Model 114-0-01



Model 174-0-01



Model 664-0-01



Model 364

**PLEASE CALL FOR  
CURRENT PRICES**



Model 636

## STEEL UNDERBED BOXES



Model 536-3-01

Model 536-5-01

### COMPACT

L	W	H	MODEL	CU. FT.
24 <sup>1</sup> / <sub>8</sub> "	12 <sup>3</sup> / <sub>8</sub> "	14 <sup>1</sup> / <sub>8</sub> "	525-3-01 *	2.3

### STANDARD

L	W	H	MODEL	CU. FT.
24 <sup>1</sup> / <sub>8</sub> "	18 <sup>1</sup> / <sub>4</sub> "	18 <sup>1</sup> / <sub>8</sub> "	524-3-01 *	4.5
30 <sup>1</sup> / <sub>8</sub> "	18 <sup>1</sup> / <sub>4</sub> "	18 <sup>1</sup> / <sub>8</sub> "	530-3-01 *	5.6
36 <sup>1</sup> / <sub>8</sub> "	18 <sup>1</sup> / <sub>4</sub> "	18 <sup>1</sup> / <sub>8</sub> "	536-3-01 *	6.7
48 <sup>1</sup> / <sub>8</sub> "	18 <sup>1</sup> / <sub>4</sub> "	18 <sup>1</sup> / <sub>8</sub> "	548-3-01 *	9.1
60 <sup>1</sup> / <sub>8</sub> "	18 <sup>1</sup> / <sub>4</sub> "	18 <sup>1</sup> / <sub>8</sub> "	560-3-01 *	11.2

### JUMBO

L	W	H	MODEL	CU. FT.
24 <sup>1</sup> / <sub>8</sub> "	24 <sup>1</sup> / <sub>4</sub> "	24 <sup>1</sup> / <sub>8</sub> "	526-3-01*	8.1
30 <sup>1</sup> / <sub>8</sub> "	24 <sup>1</sup> / <sub>4</sub> "	24 <sup>1</sup> / <sub>8</sub> "	532-3-01*	10.1
36 <sup>1</sup> / <sub>8</sub> "	24 <sup>1</sup> / <sub>4</sub> "	24 <sup>1</sup> / <sub>8</sub> "	538-3-01*	12.1
48 <sup>1</sup> / <sub>8</sub> "	24 <sup>1</sup> / <sub>4</sub> "	24 <sup>1</sup> / <sub>8</sub> "	550-3-01*	16.2
60 <sup>1</sup> / <sub>8</sub> "	24 <sup>1</sup> / <sub>4</sub> "	24 <sup>1</sup> / <sub>8</sub> "	562-3-01*	20.2

\* ALSO AVAILABLE IN BLACK



Model 911-3

Model 613-3

Model 619-3

## ACCESSORY TRAYS

	L	W	MODEL
STEEL DIVIDER TRAY	26 <sup>1</sup> / <sub>2</sub> "	14"	617-3
STEEL DIVIDER TRAY	19 <sup>1</sup> / <sub>4</sub> "	14"	615-3
STEEL DIVIDER TRAY	26 <sup>1</sup> / <sub>2</sub> "	14 <sup>5</sup> / <sub>8</sub> "	614-3
STEEL DIVIDER TRAY	19 <sup>3</sup> / <sub>4</sub> "	14 <sup>5</sup> / <sub>8</sub> "	613-3
ACCESSORY TRAY	19"	11"	911-3
STEEL TOTE TRAY	25 <sup>1</sup> / <sub>2</sub> "	9"	620-3
STEEL TOTE TRAY	18 <sup>1</sup> / <sub>2</sub> "	9"	619-3



Model 173-0-01

Model 163-0-01

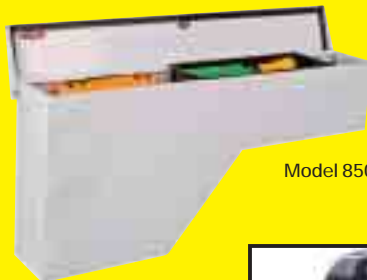

Model 8500000



## STEEL PORK CHOP BOXES

	MODEL	CU. FT.
DRIVER SIDE STANDARD	160-3-01	1.9
PASSENGER SIDE STANDARD	161-3-01	1.9
DRIVER SIDE WIDE	162-3-01	3.0
PASSENGER SIDE WIDE	163-3-01	3.0

## ALUMINUM PORK CHOP BOXES

	MODEL	CU. FT.
DRIVER SIDE STANDARD	170-0-01 *	2.1
PASSENGER SIDE STANDARD	171-0-01 *	2.1
DRIVER SIDE WIDE	172-0-01 *	3.4
PASSENGER SIDE WIDE	173-0-01 *	3.4

\* ALSO AVAILABLE IN BLACK

## STEEL WHEEL WELL BOXES

	MODEL	CU. FT.
48" WHEEL WELL	850000	3.1
60" WHEEL WELL	851000	3.5

## STORAGE DRAWERS

### UTILIZES DEAD-SPACE BEHIND WHEEL WELLS

DIAMOND PLATE	8' BED	LEFT/RIGHT	62455/62457
DIAMOND PLATE	6' BED	LEFT/RIGHT	92455/92457
WHITE	8' BED	LEFT/RIGHT	62055/62057
WHITE	6' BED	LEFT/RIGHT	92055/92057
BLACK	8' BED	LEFT/RIGHT	62155/62157
BLACK	6' BED	LEFT/RIGHT	92155/92157





## STEEL CROSSOVER BOXES

### DUAL LID

SIZE	LENGTH	MODEL	CU.FT.
FULL SIZE	70 <sup>5</sup> / <sub>8</sub> "	901000	9.0
MINI SIZE	60 <sup>5</sup> / <sub>8</sub> "	902000	5.8

### SINGLE LID

SIZE	LENGTH	MODEL	CU.FT.
FULL SIZE	70 <sup>5</sup> / <sub>8</sub> "	904000	9.0
COMPACT	60 <sup>5</sup> / <sub>8</sub> "	905000	5.8
MID SIZE	62 <sup>5</sup> / <sub>8</sub> "	906000	7.8
DEEP FULL SIZE	70 <sup>5</sup> / <sub>8</sub> "	922000	11.1

## STEEL INNERSIDE BOXES

LENGTH	MODEL	CU.FT.
48 <sup>1</sup> / <sub>2</sub> " LONG LID	820000	2.7
64 <sup>1</sup> / <sub>2</sub> " LONG LID	821000	3.5

PLEASE CALL FOR CURRENT PRICES



Model 901000



Model 904000



Model 821000



## DIAMOND-PLATE ALUMINUM HEAVY-DUTY CROSSOVER BOXES

### SINGLE LID

SIZE	LENGTH	MODEL	CU.FT.
FULL SIZE	71"	PAC1580000	9.2
MINI SIZE	61"	PAC1587000	6.1

### DUAL LID

SIZE	LENGTH	MODEL	CU.FT.
FULL SIZE	71"	PAC1596000	9.2
MINI SIZE	61"	PAC1597000	6.1

## LOW-RIDER ALUMINUM CROSSOVER BOXES

SIZE	LENGTH	MODEL	CU.FT.
FULL SIZE	71 <sup>1</sup> / <sub>8</sub> "	PAC1357000	9.1
MINI SIZE	61"	PAC1360000	6.5

### ALUMINUM CROSSOVER BOXES FEATURES:



RATCHET LOCKING SYSTEM



WATERPROOF PADDLE HANDLE



AUTOMATIC GAS SPRINGS



Model PAC1580000



Model PAC1596000



Model PAC1357000



Model PAC1360000

# DELTA PRO

## STEEL CROSSOVER BOXES

### SINGLE LID

SIZE	LENGTH	MODEL	CU.FT.
FULL SIZE	71"	PSC1455000	9.2
COMPACT	61"	PSC1458000	6.1

## STEEL INNERSIDE BOXES

LENGTH	MODEL	CU.FT.
47½" LONG LID	PSN1451000	2.6
58½" LONG LID	PSN1452000	3.2

## TOPSIDE BOXES

### ALUMINUM

L	W	H	MODEL	CU. FT.
72"	13¾"	16 <sup>5</sup> / <sub>8</sub> "	866000	8.4
87"	13¾"	16 <sup>5</sup> / <sub>8</sub> "	868000	10.2
96"	13¾"	16 <sup>5</sup> / <sub>8</sub> "	869000	11.3

### STEEL

L	W	H	MODEL	CU. FT.
72"	13½"	16½"	876000	8.4
78"	13½"	16½"	877000	9.2
87"	13½"	16½"	878000	10.2
96"	13½"	16½"	879000	11.3

## TRAILER TONGUE BOXES

### STEEL

L	H	MODEL	CU. FT.
32 <sup>7</sup> / <sub>8</sub> "	21"	422000	8.2
48"	21"	423000	12.8

### ALUMINUM

L	H	MODEL	CU. FT.
33"	21"	415000	8.2
48"	21"	416000	12.8



Model PSC1455000

Model PSN1451000



Model 866000



Model 876000



Model 423000



Model 416000



Model 810000

Model 815000

# DELTA

## STEEL HOPPER WITH LOCKDOWN MOUNTING BRACKETS

LENGTH	WIDTH	HEIGHT	MODEL
32 <sup>5</sup> / <sub>8</sub> "	11 <sup>1</sup> / <sub>4</sub> "	12 <sup>3</sup> / <sub>4</sub> "	810000

## STEEL PORTABLE UTILITY CHESTS

LENGTH	WIDTH	HEIGHT	MODEL
32 <sup>5</sup> / <sub>8</sub> "	14 <sup>3</sup> / <sub>4</sub> "	13"	814000
48 <sup>1</sup> / <sub>2</sub> "	21 <sup>3</sup> / <sub>4</sub> "	18 <sup>13</sup> / <sub>4</sub> "	815000



## ALUMINUM CROSS BOXES

Single lid cross body toolboxes with sleek, low profile design. Patented dual action slam locks feature an innovative tandem latch system that opens both locks at once, from either side of the box. Also available in dual lid design.



Model 54-8221

## ALUMINUM IN-BED BOX

Feature a convenient chest-style design. Inbed boxes also feature patented dual action lock. All boxes may be ordered with smooth or diamond plate lids at no additional charge. Available in width from 38" to 63" to fit any truck.



Model 54-8440

## ALUMINUM SIDE RAIL BOX

Available in 12" wide or 16" wide. Low profile design. Available in 36", 48", 60", 72", & 90" lengths.



Model 54-8620-60

## ALUMINUM SUV STORAGE BOX

Top open, smooth body, diamond plate lid. Designed for frame mounting.



Model 20-2410

**CUSTOM-MADE  
BOXES  
AVAILABLE  
CALL STORE FOR DETAILS!**

## CAB RACKS

All aluminum, lightweight construction means low maintenance and top-notch looks.



Mesh Cab Rack

*All Pro-Tech boxes can be ordered with smooth or diamond plate lids.*



Louvered Cab Rack

*Many other style boxes also available.*

## BACK PACK BOX

Available with diamond plate, smooth aluminum, or stainless steel doors. Two standard shelves included.



Back Pack Box

**PLEASE CALL FOR CURRENT PRICES**



Single Lid Cross Box



Single Lid Low Profile Cross Box



Chest Boxes



## PICKUP TRUCK STORAGE BOXES

Taylor Wing boxes feature heavy duty stainless steel latch, extra large reinforcing lid stiffener, 85° door opening, continuous rain channel design, 12 volt access and full length latch and linkage cover.

Tru-Fit lid design eliminates over hanging lids! Available in bight aluminum finish or black powder coat.



Single Lid Saddle Box



Gull Wing Saddle Box



Lockup Boxes



The Roller Coaster™ 2000-XT



The Pickup Pack™



## SINGLE LID & GULL WING SADDLE BOXES

Comes standard with diamond plate doors with mirror finished face. Features Lifetime Warranty, stainless steel T-handle locks, oversized stainless steel hinges, heavy guage 1/8" marine grade aluminum, automotive grade weather stripping and first class engineering put this tool box in that "over the top" class.

(Single lid box shown with optional accessories)

## LOCKUP BOXES

Turn the back of your SUV into a secure storage vault. Built with heavy guage 1/8" marine grade aluminum, and rugged stainless steel T-handle locks. Ball bearing drawers slides rated at 300 pounds. Lifetime warranty.

## THE ROLLER COASTER™ 2000-XT

SLIDING CARGO TRAY WITH 2000 LBS. CAPACITY!

For pickups and vans. Heavy guage 1/8" thick all aluminum tray. Easy installation, holds a 4 x 8 sheet of plywood. Lifetime warranty.

## THE PICKUP PACK™

URNS YOUR PICKUP BED INTO A SERVICE BODY!

When you need storage, but dont want a service body...this is your solution! Heavy guage 1/8" aluminum construction. Low access style door design. Center hatch also locks tailgate. Stainless steel T-locks. Lifetime warranty.



# VAN ACCESSORIES

We offer a full selection of van accessories. Choose from over 40 pre-packaged units for different size vans or design your own custom interior using separate components.



**PLEASE CALL FOR CURRENT PRICES**



## BULKHEAD PANELS

BULKHEAD STYLE	VAN SIZE	MODEL
SCREEN	FULL SIZE	86500-3-01
SOLID	FULL SIZE	86520-3-01
SLIDING DOOR	FULL SIZE	86300-3-01
LEXAN WINDOW	FULL SIZE	86510-3-01
SWING DOOR HINGE KIT*	FULL SIZE	86555-3-01
DRIVER PANEL	FULL SIZE	86001-3-01
PASSENGER PANEL	FULL SIZE	86002-3-01
SCREEN	SPRINTER	85500-3-01
SWING DOOR HINGE KIT*	SPRINTER	85555-3-01
SCREEN	MINI	88500-3-01

\*USE WITH SCREEN BULKHEAD



Model 86500



Model 86520



Model 86300



Model 86510



Model 86001/86002



Model 85500



## WELDED E-Z® CUBE SHELVING FOR FULL SIZE VANS

H	L	D TOP	D BOTTOM	SHELVES	MODEL
43¾"	42"	11¼"	13¾"	4	9400-3-01
43¾"	51"	11¼"	13¾"	4	9452-3-01

## WELDED STACK UNIT SHELVING

Mounts to floor or on top of Wheel Well Base Cabinet

H	L	D	SHELVES	DIVIDERS	MODEL
30"	36"	12"	3	6	8230-3-01

## KNOCKDOWN JUMBO SHELVING

Completely customize your van storage!

### 30" TALL SHELF UNITS

H	L	D	SHELVES	DIVIDERS	MODEL
30¼"	30¼"	14"	2	8	8320-3-01
30¼"	36¼"	14"	2	8	8332-3-01
30¼"	42¼"	14"	2	8	8342-3-01
30¼"	51¼"	14"	2	8	8352-3-01

### TAPERED 43¾" TALL SHELF UNITS

H	L	D	SHELVES	DIVIDERS	MODEL
43¼"	36¼"	14"	3	12	8433-3-01
43¼"	42¼"	14"	3	12	8443-3-01
43¼"	51¼"	14"	3	12	8453-3-01
43¼"	60¼"	14"	3	12	8463-3-01

### 43¾" TALL SHELF UNITS

H	L	D	SHELVES	DIVIDERS	MODEL
43¼"	42¼"	18"	3	12	8380-3-01
43¼"	51¼"	18"	3	12	8381-3-01
43¼"	42¼"	24"	3	12	8390-3-01
43¼"	51¼"	24"	3	12	8391-3-01

### TAPERED 57½" TALL SHELF UNITS

H	L	D	SHELVES	DIVIDERS	MODEL
57½"	42¼"	14"	3	12	8474-3-01
57½"	51¼"	14"	3	12	8475-3-01
57½"	69¼"	14"	3	12	8476-3-01

### 59½" TALL SHELF UNITS

H	L	D	SHELVES	DIVIDERS	MODEL
59½"	42¼"	18"	3	12	8383-3-01
59½"	51¼"	18"	3	12	8384-3-01
59½"	69¼"	18"	3	12	8385-3-01
59½"	42¼"	24"	3	12	8393-3-01
59½"	51¼"	24"	3	12	8394-3-01
59½"	69¼"	24"	3	12	8395-3-01



Model 8230-3-01

Model 8230-3-01



Model 8391-3-01

Model 8453-3-01



Model 8320-3-01  
(shown with accessories)

**FULL LINE OF  
SHELVING  
ACCESSORIES  
AVAILABLE!**



## LOCKABLE CABINET

SHELVES	H	W	D	MODEL
2	24"	17"	18"	8310-3
2	18"	17"	11¾"	8311-3
1	24"	17"	11¾"	8312-3

## CATV BOXES

SHELVES	H	W	D	MODEL
0	20"	20"	17½"	8313-3
4	21"	20"	14"	8316-3

## PARTS CABINETS

DRAWERS	H	W	D	MODEL
9	12"	17"	11¾"	8909-3
18	12"	32½"	11¾"	8918-3
8	8¼"	22⅛"	11¾"	8908-3
6	4½"	32½"	11¾"	8906-3

## PARTS BOXES

ITEM	H	W	D	MODEL
BOX	3"	18"	12"	8930-3
RACK	15¾"	21¼"	12¾"	8931-3

## LITERATURE HOLDERS

BINS	H	W	D	MODEL
4	15"	13"	6½"	8880-3
6	15"	13"	4¾"	8870-3
3	36"	6"	12"	8361-3

**PLEASE CALL FOR CURRENT PRICES**

## DRAWER UNITS

DRAWERS	H	W	D	MODEL
9	24"	12½"	11¾"	8905-3
4	24"	17"	18"	8914-3
4	24"	17"	11¾"	8904-3
3	18"	17"	11¾"	8903-3
2	12"	17"	11¾"	8902-3
4	24"	17"	11¾"	8901-3
3	5½"	32½"	11¾"	8913-3





**PLEASE  
CALL FOR  
CURRENT  
PRICES**



Model 8470-3



Model 8861-3



Model 8867-3  
(shown with 8901-3, 8902-3, 8141-3-01)



Model 8868-3



Model  
8894-3



Model 8881-3



Model 8895-3



Model 8882-3

### DOOR TRAY

Holds hanging file folders within easy reach. Mounts between the seats of all full size vans. Features clip paper holder, keyed lock and sliding tray.

H	W	TRAYS	MODEL
21¾"	20¼"	3	8470-3

### VAN FLOOR MATS

Protects floor from normal wear & tear, prevents cargo from shifting, and reduces noise. 3/16" thick rubber.

Sizes to fit most full and mini vans.  
MODEL 89015, 89017, 89050, 89011

### FILE BOX

Holds hanging file folders within easy reach. Mounts between the seats of all full size vans. Features clip paper holder, keyed lock and sliding tray.

VAN SIZE	H	W	D	MODEL
FULL SIZE	15½"	13¼"	18"	8861-3
MINI	15"	9¼"	20¼"	8878-3

### STEEL WORK TOP

For mounting to top of Cabinet Base and Drawer Units

L	D	MODEL
42½"	18"	8867-3

### WIRE SPOOL RACK

H	W	D	MODEL
42½"	19¾"	16¼"	8868-3

### TANK HOLDER

H	W	D	MODEL
12¾"	7"	7"	8894-3

### TANK RACK

H	W	D	HOLDS	MODEL
40"	15½"	8"	2-30#, 1-50#	8881-3
45½"	15½"	8"	3-50#	8895-3
48½"	13"	8"	4-30#	8882-3



## PACK RATS® DRAWER UNITS

### 24" LONG

W	H	COMPARTMENTS	DIVIDERS	MODEL
30"	9"	3	12	312-3
30"	12½"	3	12	301-3
39¾"	12½"	4	12	303-3

### 48" LONG

W	H	COMPARTMENTS	DIVIDERS	MODEL
10¼"	9"	1	6	305-3
20"	9"	2	12	306-3
30"	9"	3	18	307-3
39¾"	9"	4	24	308-3
10¼"	12½"	1	6	335-3
20"	12½"	2	12	336-3
30"	12½"	3	18	337-3
39¾"	12½"	4	24	338-3

### 48" LONG - WITH WIDE COMPARTMENT

W	H	COMPARTMENTS	DIVIDERS	MODEL
30"	9"	1 REG/1 WIDE	6	304-3
30"	12½"	1 REG/1 WIDE	6	334-3

### OPTIONAL DIVIDERS 6 PER SET

DESCRIPTION	MODEL
FITS MODELS 304, 305, 306, 307, 308, 312	300
FITS MODELS 301, 303, 334, 335, 336, 337, 338	302

## ITEMIZERS® DRAWER UNITS

DRAWERS	L	W	H	MODEL
1 LATERAL	49"	12¼"	6¾"	314-3
2 LATERAL	49"	24"	6¾"	316-3
3 LATERAL	49"	36"	6¾"	317-3
4 LATERAL	49"	48"	6¾"	318-3
2 STACKED	49"	12¼"	12¼"	326-3
3 STACKED	49"	12¼"	17¾"	327-3
4 STACKED	49"	12¼"	23½"	328-3

## BED RATS® SLIDING PLATFORM

SPECIAL ORDER - ALLOW 4 WEEKS FOR DELIVERY

DOOR TYPE	L	W	H	MODEL
SIDE DOOR	54"	22"	4¾"	3100
REAR DOOR	68"	44¾"	4¾"	3200
REAR DOOR	80"	44¾"	4¾"	3300
REAR DOOR	90"	44¾"	4¾"	3400



Model 312-3



Model 304-3

Model 306-3



Model 314

Model 317



Model 328

**PLEASE  
CALL FOR  
CURRENT  
PRICES**



Model 3200

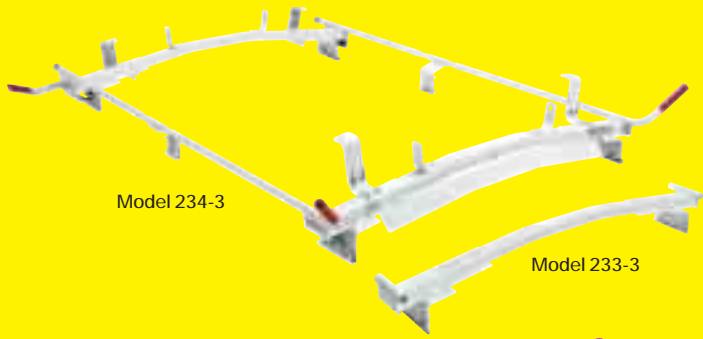

Model 234-3

Model 233-3



Model 205-3



Model 210-3



Model 240



Model 239

Model 237



Model 2511

Model 251

## ALUMINUM QUICK-CLAMP RACK

Quick-clamp rack features full-length side rails, extra-wide mounting bases, & lockable clamping. For full-size & mini vans with rain gutters.

RACK CURB & STREET SIDE CLAMPS

MODEL 234-3

### ACCESSORY CROSS MEMBER

Use with Quick Clamp Rack to accommodate short ladders and provide additional support.

MODEL 233-3

USE WITH 234 OR 236

## ALL-PURPOSE STEEL VAN RACK

Installs quickly to gutters and carries loads securely. Wide mounting bases prevent rocking. Includes complete cross member set with moveable tie-down loops.

VAN FULL SIZE ASTRO/SAFARI

MODEL 205-3 220-3

## SAFARI RACK

Excellent for hauling all types of materials. Wide enough for four foot wide sheets of material. Installation is easy and all hardware is provided. Everything bolts tightly into place.

FOR FULL SIZE VANS

MODEL 210-3

## RACK ACCESSORIES

Installs quickly to gutters and carries loads securely. Wide mounting bases prevent rocking. Includes complete cross member set with moveable tie-down loops.

LADDER GUIDE CONDUIT CARRIER KIT ALUMINUM CONDUIT CARRIER

MODEL 240-3 239 237

## THE EZ-GLIDE™ SYSTEM

Hydraulic action assists with raising and lowering your ladders with just a flip of a lever. Each system includes passenger side drop down system and a basic ladder rack on the driver's side.

VEHICLE SIZE FITS FORD/DODGE FULL SIZE FITS CHEVY/GMC FULL SIZE FITS CHEVY/GMC MINI SIZE FITS SPRINTER VAN W/HIGH ROOF FITS SPRINTER VAN W/STANDARD ROOF

MODEL 251 252 253 280 285

### DRIVER'S SIDE DROP DOWN KIT

Use w/EZ-Glide™ rack system to add drop down feature to driver's side of van.

USE WITH 251, 252, 253

MODEL 255

### ACCESSORY CROSS MEMBER

USE WITH 251 USE WITH 252 USE WITH 253

MODEL 2511 2521 2531



## ALUMINUM GEAR FUEL PUMPS

NOZZLE TYPE	FLOW RATE	MODEL
MANUAL	UP TO 15 GPM	M150S-MU
AUTOMATIC	UP TO 15 GPM	M150S-AU



Model M150S-MU



Model M150S-AU



## FUEL PUMPS

DESCRIPTION	MODEL
HAND ROTARY PUMP	112
DOUBLE ACTING HAND PUMP	FR152
12 VOLT DC PUMP WITHOUT METER	FR1210C
12 VOLT DC PUMP WITH METER	FR1211C

## PUMP ACCESSORIES

DESCRIPTION	MODEL
REBUILD KIT FOR 1210-1211 PUMP	1200-70
FILTER KIT FOR 1210-1211 PUMP	F7019
REPLACEMENT SWITCH FOR 1210-1211 PUMP	3170
REPLACEMENT TANK CAP	7380
REPLACEMENT FILTER	F7012
AUTOMATIC SHUT-OFF HANDLE	F3144
STANDARD ELECTRICAL PUMP HANDLE	700-57
12' REPLACEMENT HOSE	9810-8455



Model 112



Model FR-152



Model 1210



Model 1211



## LIQUID TRANSFER TANKS

SIZE	SHAPE	LENGTH	MODEL
47 GALLONS	L-SHAPED*	32¼"	350-3-01
70 GALLONS	L-SHAPED*	43¼"	352-3-01
88 GALLONS	L-SHAPED*	52"	354-3-01
100 GALLONS	RECTANGLE	45¼"	358-3-01
110 GALLONS	L-SHAPED*	56"	360-3-01

\*L-SHAPED, FOR USE WITH BOX



Model 350-3-01

Model 352-3-01



Model 354-3-01

Model 358-3-01



Model 360-3-01



## TOOL & FUEL COMBO TANKS

Auxiliary tank with tool storage. Tie into your factory fuel system or add a 12 Volt 9 GPM Fuel Transfer Pump with a hose and nozzle kit.



## LIQUID TRANSFER TANKS



### STEEL

SIZE	SHAPE	LENGTH	MODEL
103 GALLON	L-SHAPED*	59 <sup>5</sup> / <sub>8</sub> "	480000
103 GALLON	L-SHAPED*	60 <sup>1</sup> / <sub>4</sub> "	480000**
56 GALLON	L-SHAPED*	37"	481000
51 GALLON	L-SHAPED*	29 <sup>5</sup> / <sub>8</sub> "	482000
96 GALLON	RECTANGLE	45 <sup>1</sup> / <sub>4</sub> "	484000
50 GALLON	SQUARE	23 <sup>1</sup> / <sub>4</sub> "	485000
37 GALLON	VERTICAL	59 <sup>5</sup> / <sub>8</sub> "	486000
98 GALLON	L-SHAPED*	60"	498000***

### STEEL LOW PROFILE

SIZE	SHAPE	LENGTH	MODEL
86 GALLON	L-SHAPED*	54"	487000
76 GALLON	L-SHAPED*	48"	488000
42 GALLON	L-SHAPED*	26 <sup>1</sup> / <sub>2</sub> "	489000

### ALUMINUM

SIZE	SHAPE	LENGTH	MODEL
99 GALLON	L-SHAPED*	57 <sup>1</sup> / <sub>2</sub> "	437000
91 GALLON	RECTANGLE	45 <sup>1</sup> / <sub>4</sub> "	438000
47 GALLON	SQUARE	23 <sup>1</sup> / <sub>4</sub> "	439000

\*L-SHAPED, FOR USE WITH BOX

\*\*STEEL TANK WITH ALUMINUM SHELL

\*\*\*DESIGNED FOR USE WITH 4-DOOR TRUCKS



## ALUMINUM LIQUID TRANSFER TANKS

SIZE	SHAPE	LENGTH	MODEL
50 GALLON	SQUARE	24 <sup>1</sup> / <sub>4</sub> "	37024152
100 GALLON	RECTANGULAR	54 <sup>1</sup> / <sub>4</sub> "	37024151
36 GALLON	VERTICAL	45 <sup>1</sup> / <sub>4</sub> "	37024153
75 GALLON	L-SHAPED*	48 <sup>1</sup> / <sub>4</sub> "	37024158
95 GALLON	L-SHAPED*	54 <sup>1</sup> / <sub>4</sub> "	37024150
75 GALLON	TANK/BOX COMBO	48 <sup>1</sup> / <sub>4</sub> "	37024159

\*L-SHAPED, FOR USE WITH BOX

PLEASE CALL FOR CURRENT PRICES



## ALUMINUM TRUCK RACK

Made from strong, lightweight aluminum that is anodized to resist oxidation. Maintains a bright, good looking finish for years. Sleek, stylish appearance. Easy to install.

Includes 4 uprights, 4 mounting bases, 2 cross members, 4 ladder stops.

VEHICLE SIZE	MODEL
FULL SIZE TRUCKS	1200
COMPACT TRUCKS	1205

## ACCESSORY SIDE RAILS

Includes 2 side rails and 1 front cross member.

VEHICLE SIZE	MODEL
FULL SIZE TRUCKS W/8' BED	1210
COMPACT OR FULL SIZE W/6.5' BED	1211

CROSS MEMBER	1215
QUICK RELEASE - 2 pack	1218

Allows quick removal of rear cross member.



Model 1200 & 1210

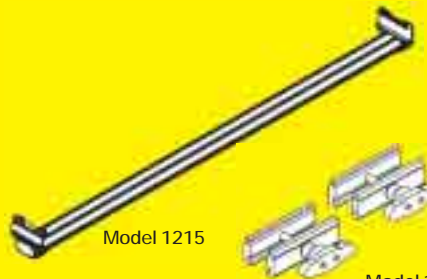

Model 1215

Model 1218

**PLEASE CALL FOR CURRENT PRICES**



## SLIDING TRACK RACK SYSTEM

Rack slides along base rails. Reposition or remove racks in seconds. Rugged aluminum, no rust or corrosion. Carries 1,000 lbs. - weighs just 77 lbs. Install without drilling or bolting.



## RACK ACCESSORIES

	MODEL
HOOK Side mount hook holds coiled materials.	31150
COOLER MOUNT Mounts Igloo style water barrel to leg of rack.	31160
LIGHT MOUNT Mounts emergency flasher lights to any location on side rails.	31170





Model 1000



Model 2000



Model 3000



Model 6000

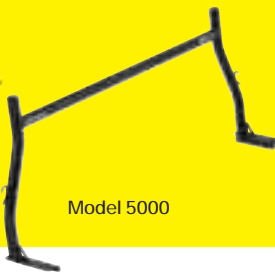

Model 5000



## FULL SIZE TRUCK RACKS

Heavy duty welded steel construction of 1½" round tubing prevents twisting and flexing. Gloss black, heavy duty industrial grade paint. Angle runs full length of bed to evenly distribute weight. Equipped with removable rear crossbar for easy loading.

DESCRIPTION	SERIES
STANDARD RACK	1000
(Model 1000 also available in white finish)	
DROP SIDE (loadable with a forklift)	2000
DROP SIDE (for extended cab)	2000
CAMPER SHELL SERIES	3000
HEADACHE RACK	5000
HEADACHE RACK (welded screen)	6000

**ALSO AVAILABLE  
CUSTOM MADE  
UTILITY BED RACKS**



Model 1475



Model 1450



## WEEKENDER® LADDER RACKS

The lighter duty ladder racks for the person with the occasional need to carry a ladder or small quantities of long materials. Constructed of 1½" x 1½", 14 gauge steel tubing for a 250 pound capacity. Removable uprights.

STYLE	COLOR	MODEL
ANGULAR	BLACK	1475-5-01
ANGULAR	WHITE	1475-3-01
HORIZONTAL	BLACK	1450-5-01
HORIZONTAL	WHITE	1450-3-01

**PLEASE  
CALL FOR  
CURRENT  
PRICES**

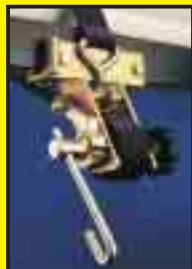

## RACK-STRAP

### TRUCK RACK LOAD STRAPS

To secure any load to your rack.

DESCRIPTION	MODEL
FOR ROUND STYLE RACKS	RS-2
FOR SQUARE TUBE RACKS	RS-1



Consult vehicle owners manual for recommended vehicle towing capacity

## ONE-PIECE CUSTOM FIT HITCHES

Let us know what vehicle you have and what you want to tow, and we'll supply you with the perfect hitch! Hitches include ball mount, pin & clip and receiver cover. Durable black corrosion-resistant powdercoat finish.

CLASS	RECEIVER SIZE	GROSS TRAILER WT.	TONGUE WEIGHT
CLASS I	1¼"	2,000 LBS	200 LBS
CLASS II	1¼"	3,500 LBS	300 LBS
CLASS III	2"	3,500-6,000*	300-500 LBS
CLASS IV	2"	10,000	1,200 LBS

\*maximum duty 10,000 GTW with weight distributing hitch



## FOLDING BALL GOOSENECK HITCH

Balls stores when not in use. Installation kits sold separately.

MODEL	RECEIVER SIZE	GROSS TRAILER WT.	TONGUE WEIGHT
69890	2 5/16"	25,000 LBS	5,000 LBS

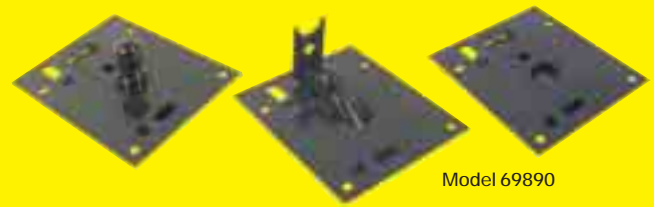

## WEIGHT DISTRIBUTING HITCH

Complete kit with round bar. Includes weight distributing shank., dual sway control platform, raised ball platform for greater coupler clearance.

MODEL	GROSS TRAILER WT.	TONGUE WEIGHT
70210	10,000	400-600 LBS
70220	10,000	501-800 LBS
70230	10,000	801-1,000 LBS
70350	12,000	801-1,200 LBS



## SWAY CONTROL

Dual friction brake pad system provides constant and adjustable sway reduction. Minimizes trailer sway caused by high winds, curvng roads, or sudden maneuvers. Mounts to weight distribution hitch (sold separately). Detaches quickly for storage. MODEL 75190

PLEASE CALL FOR CURRENT PRICES



## SUSPENSION ENHANCEMENT

Provides boost to existing suspension.

Load sensitive, adjusts automatically.

Retains factory ride quality and reduces body roll up to 30%.

Available for all trucks!



Consult vehicle owners manual for recommended vehicle towing capacity



Model 59470



Model 75100



Model 76520



Model 76430



Model 76500



Model 76410



Model 76510



Model 53920



Model 76550  
Black Powdercoat  
Finish



Model 76210  
Chrome Finish



Model 76600

## BLACK POWDER-COATED BALL MOUNT

### FITS 1 1/4" RECEIVERS

RISE/DROP	BALL SHANK HOLE	WEIGHT RATING	MODEL
5/8" RISE	3/4"	2,000 LBS	59470
2 1/4" RISE	3/4"	2,000 LBS	59490
4" RISE	3/4"	2,000 LBS	59400

### FITS 2" RECEIVERS

RISE/DROP	BALL SHANK HOLE	WEIGHT RATING	MODEL
2 1/4" DROP	1"	6,000 LBS	75100
2 1/4" DROP	1"	6,000 LBS	75900
3 1/4" DROP	1"	5,000 LBS	75910
5" DROP	1"	5,000 LBS	75880
5" DROP	1"	5,000 LBS	75940
10" DROP	3/4"	3,500 LBS	75160

## CHROME FINISH BALL MOUNT

### FITS 2" RECEIVERS

RISE/DROP	BALL SHANK HOLE	WEIGHT RATING	MODEL
2 1/4" DROP	1"	5,000 LBS	76520
3 1/4" DROP	1"	5,000 LBS	76530

## STAINLESS STEEL BALL MOUNT

### FITS 2" RECEIVERS

RISE/DROP	BALL SHANK HOLE	WEIGHT RATING	MODEL
2" DROP	1"	6,000 LBS	76430
3 1/2" DROP	1"	5,000 LBS	76440

## HEAVY DUTY BALL MOUNT

### FITS 2" RECEIVERS

RISE/DROP	BALL SHANK HOLE	WEIGHT RATING	MODEL
2" DROP	1 1/4"	10,000 LBS	76490
4" DROP	1 1/4"	10,000 LBS	76500
6" DROP	1 1/4"	10,000 LBS	76510
8" DROP	1 1/4"	7,500 LBS	76410

## REDUCER BUSHING

Reduces ball mount hole to provide proper fit for ball.

SIZE	MODEL
REDUCES 1" TO 3/4"	53920
REDUCES 1 1/4" TO 1"	53940

## MULTIPLE BALL & MOUNT

Use when towing a variety of sizes and weights of trailers.  
Double ball has 1 7/8" & 2" balls, triple has 1 7/8", 2", & 2 5/16" balls.

### FITS 2" RECEIVERS

# OF BALLS	WEIGHT RATING	MODEL
DOUBLE	2,000 & 5,000 LBS	76550
TRIPLE	2,000, 5,000 & 10,000 LBS	76210

## BOLT TOGETHER SHANK

MODEL 76600



Quality since 1946

## MULTIPLE-BALL HITCH

**BALL SIZES**

2" & 2<sup>5</sup>/<sub>16</sub>"  
 1<sup>7</sup>/<sub>8</sub>" & 2", & 2<sup>5</sup>/<sub>16</sub>" BLACK  
 1<sup>7</sup>/<sub>8</sub>" & 2", & 2<sup>5</sup>/<sub>16</sub>" CHROME

**MODEL**

B1802215  
 B1802200  
 B1802205



Model 1802200

Model 1802205

Model 1802225

Model RM62000

## ADJUSTABLE MULTIPLE-BALL HITCHES

WITH 12" VERTICAL ADJUSTMENT

**BALL SIZES**

1<sup>7</sup>/<sub>8</sub>" & 2", & 2<sup>5</sup>/<sub>16</sub>" CHROME

**MODEL**

B1802225

## RECEIVER MOUNT COMBINATION BALL HITCH

**BALL SIZE**

2"

**MODEL**

RM62000



## ADAPT HITCH BALL SETS

CHROME

SHAFT	# OF BALLS	SIZES	MODEL
3/4"	2	1 <sup>7</sup> / <sub>8</sub> " & 2"	51750
1"	2	1 <sup>7</sup> / <sub>8</sub> " & 2"	51760
1"	2	2" & 2 <sup>5</sup> / <sub>16</sub> "	51770
1"	3	1 <sup>7</sup> / <sub>8</sub> ", 2" & 2 <sup>5</sup> / <sub>16</sub> "	51810
1" (XL)	3	1 <sup>7</sup> / <sub>8</sub> ", 2" & 2 <sup>5</sup> / <sub>16</sub> "	51820
<b>STAINLESS STEEL</b>			
3/4"	2	1 <sup>7</sup> / <sub>8</sub> " & 2"	87800
1"	3	1 <sup>7</sup> / <sub>8</sub> ", 2" & 2 <sup>5</sup> / <sub>16</sub> "	87900

PLEASE CALL FOR CURRENT PRICES



Model 51810



Model 51760



## TOW & STOW™ RECEIVER HITCH

Revolutionary hitch designs lets you twist, slide, pivot, flip, and swing your new hitch to accommodate any of your towing needs!

Stows under vehicle when not in use.

BALLS	BALL SIZE	DROP	MODEL
TWO	2" & 2 <sup>5</sup> / <sub>16</sub> "	6" DROP	TS10033B
TWO	2" & 2 <sup>5</sup> / <sub>16</sub> "	8" DROP	TS10037B
THREE	1 <sup>7</sup> / <sub>8</sub> ", 2" & 2 <sup>5</sup> / <sub>16</sub> "	6" DROP	TS10047B
THREE	1 <sup>7</sup> / <sub>8</sub> ", 2" & 2 <sup>5</sup> / <sub>16</sub> "	8" DROP	TS10048B



Model TS10047B

ADJUST IT!

ROTATE IT!

STOW IT!

**WE HAVE A  
LARGE SELECTION  
OF HITCH BALLS!**



Model 74610



Model 69982



Model 69952



Model 50812



Model 69900



Model 69930



Model 69940



Model 69922



Model 69912



Model 53312

**PLEASE CALL FOR CURRENT PRICES**

**Valley**

**CHROME TRAILER HITCH BALLS**

BALL DIA.	SHANK	GTW	MODEL
1 7/8"	3/4" x 1 3/4"	2,000 LBS	50010
1 7/8"	3/4" x 2 5/16"	2,000 LBS	50500
1 7/8"	1" x 2 1/8"	2,000 LBS	50660
1 7/8"	1" x 2 7/8"	2,000 LBS	50090
2"	3/4" x 1 3/4"	3,500 LBS	50030
2"	3/4" x 2 5/16"	3,500 LBS	50520
2"	1" x 2 1/8"	6,000 LBS	50280
2"	1" x 2 7/8"	6,000 LBS	50110
2 5/16"	1 1/4" x 2 1/4"	10,000 LBS	50670

**TOWING ACCESSORY KIT**

Includes ball mount, 5/8" hitch pin and clip, trailer ball, American flag receiver cover, & storage case.

SIZE	GTW	MODEL
2" BALL	6,000 LBS	74610

**PINTLE HOOKS**

TOWING CAPACITY	VERTICAL TONGUE WEIGHT	MODEL
11,000 LBS (5.5 TONS)	1,650 LBS	69950
20,000 LBS (10 TONS)	4,000 LBS	69952
30,000 LBS (15 TONS)	6,000 LBS	69953

**PINTLE HOOKS WITH CHROME BALL**

BALL SIZE	GTW	VERTICAL TONGUE WEIGHT	MODEL
2"	10,000 LBS*	1,000 LBS*	69972
2 5/16"	10,000 LBS*	1,000 LBS*	69982

\* 16,000 LBS GTW & 3,000 LBS VTW WITH LUNETTE EYE

**REPLACEMENT  
CHROME PINTLE HITCH BALLS**

SIZE	GTW	MODEL
2"	10,000 LBS	50812
2 5/16"	10,000 LBS	50872

**PINTLE HOOK ADAPTERS**

Multiple position mounting allows for 1 3/4" incremental height adjustments. Can be used in rise or drop position. Fits 2" receivers.

DROP	GTW	TONGUE WEIGHT	MODEL
3 1/2" DROP	10,000 LBS	1,000 LBS	69900
5 1/4" DROP	10,000 LBS	1,000 LBS	69430
1 3/4" DROP	5,000 LBS	500 LBS	69910

**LUNETTE RINGS**

RING SIZE/TYPE	RATING	MODEL
2 1/2" w/THEADED SHANK	15,000 LBS	69930
3" w/THEADED SHANK	45,000 LBS	69932
2 1/2" w/MOUNTING PLATE	42,000 LBS	69940
3" w/MOUNTING PLATE	60,000 LBS	69942
3" w/3 POSITION CHANNEL	12,000 LBS	69922

**REPLACEMENT CHANNELS**

	MODEL
3 POSITION (for use with #69922)	69902
5 POSITION (for use with #69922)	69912
BOLT & NUT KIT (for use with #69922)	53312



## RECEIVER TUBE WITH COLLAR

LENGTH	INSIDE DIA.	MODEL
6"	2"	75240
8"	2"	74970
12"	2"	75250
24"	2"	75260
36"	2"	75360
48"	2"	75370
6"	1 1/4"	74950
12"	1 1/4"	74960

## HITCH ADAPTER

SIZE	MODEL
CONVERTS 1 1/4" TO 2"	76130

*For use with bike racks and accessories, NOT TO BE USE FOR TOWING.*

## CLEVIS BALL MOUNT

SIZE	TONGUE WT.	MODEL
9 1/2" x 2" x 2"	350	75890
10 1/2" x 2" x 2"	900	75970
CLEVIS PIN - 3/4"		76000
CLEVIS PIN - 1"		76160

## HITCH LOCKS

	SIZE	MODEL
PIN & CLIP	1/2" DIA.	75810
PIN & CLIP	5/8" DIA.	75830
LOCK	1/2" DIA.	75730
LOCK	5/8" DIA.	75710
SILENT LOCK	5/8" DIA.	76820
LOCK	1/2" DIA.	75750
LOCK	5/8" DIA.	75740
ADJ. LOCK	1/2" & 5/8" DIA.	75630
COMBO	5/8" DIA.	76850
COUPLER LOCK		75680
UNIVERSAL COUPLER LOCK		75692

## RECEIVER COVERS

Express yourself with our large selection of receiver covers.

## FLIP STEP

Easily reach the top of your vehicle when down, flips up to reveal brake light and running light combo.

RECEIVER	PLATFORM SIZE	MODEL
1 1/4"	5 3/4" x 7 1/4"	91450
2"	5 3/4" x 7 1/4" (SUV)	91470
2"	5 3/4" x 7 1/4" (PU)	91490





## STANDARD SERIES BIKE CARRIERS

Protective rubber extrusions to help protect bikes.

SIZE	MOUNT	MODEL
HOLDS 3 BIKES	FITS BOTH 1¼" & 2"	90630
HOLDS 4 BIKES	FITS BOTH 1¼" & 2"	90650

## DELUXE SERIES BIKE CARRIERS

Adjustable, independent clamps. Lock knob included.

Models 91330 & 91331 fold closed for easy storage when not in use.

SIZE	MOUNT	MODEL
HOLDS 3 BIKES	FITS BOTH 1¼" & 2"	91330
HOLDS 4 BIKES	FITS BOTH 1¼" & 2"	91331

## MULTI-USE BALL MOUNT

Tow and carry accessories such as racks or cargo carriers at the same time! Fits 2" receivers.

SIZE	RECEIVER RATING	BALL MOUNT RATING	MODEL
3¼" DROP	500 LBS	5,000 LBS	75090

## ROOF BOX

High molecular weight polyethylene, UV stabilized. Passenger-side opening with quick release snap-lock mechanism. Camlock with two keys for security. Compatible with round or square bar racks and most factory rack systems. Includes U-bolt mounting kit.

L	W	H	HOLDS	MODEL
55"	38"	19½"	110 LBS	90551

**PLEASE CALL FOR CURRENT PRICES**

## HITCH MOUNTED CARGO CARRIERS

SIZE	STYLE	MODEL
60" x 20" x 3" BASKET	FOLDING	90180
60" x 20" x 6" BASKET	FIXED	90590
60" x 20" x 6" BASKET	FOLDING	90190

## ROOF CARGO CARRIERS

Extendable, lightweight roof basket for mid to full size SUVs or Sport Utility vehicles. Fits most factory rack systems.

SIZE	MODEL
43½" x 37¼" x 4"	90350
21" EXTENSION	90360



Model 90630

Model 91330



Model 75090



Model 90551



Model 90180



Model 90590



Model 90190



Model 90360

Model 90350



## TRAILER JACKS

	<u>WT. CAPACITY</u>	<u>MODEL</u>
TOP WIND	1,000 LBS	76040
TOP WIND	5,000 LBS	76050
SIDE WIND	2,000 LBS	76230
TOP WIND	2,000 LBS	76280

### WITH FOOT

	<u>WT. CAPACITY</u>	<u>MODEL</u>
TOP WIND	2,000 LBS	76060*
ROP WIND	2,000 LBS	76070*

\*order mounting brackets separately for 76060 & 76070

### WITH WHEEL

	<u>WT. CAPACITY</u>	<u>MODEL</u>
TOP WIND	2,000 LBS	76290

### ACCESSORIES

FITS 76050, 76230, & 76280

	<u>MODEL</u>
CASTER	76180
JACK FOOT	76360

## TRAILER COUPLER

<u>BALL/CHANNEL SIZE</u>	<u>GROSS LOAD</u>	<u>MODEL</u>
1 <sup>7</sup> / <sub>8</sub> " / 2 <sup>1</sup> / <sub>2</sub> " QUICK LOCK	2,000 LBS	54210
1 <sup>7</sup> / <sub>8</sub> " / 3" QUICK LOCK	2,000 LBS	54220
2" / 2 <sup>1</sup> / <sub>2</sub> " QUICK LOCK	3,500 LBS	54240
2" / 3" QUICK LOCK	3,500 LBS	54250
A-FRAME (FOR MOBILE HOMES)	25,000 LBS	51090

## WINCHES

	<u>RATED CAPACITY</u>	<u>MODEL</u>
1-WAY RATCHET	900 LBS	54030
REVERSIBLE	1,400 LBS	54050

## SAFETY CHAINS & CLIPS

	<u>GROSS LOAD</u>	<u>MODEL</u>
CLASS III CHAIN	5,000 LBS	52580
CLASS II HOOK	3,500 LBS	52630

## TRAILER BRAKE CONTROLS

	<u>SKU</u>	<u>MODEL</u>
2-8 BRAKE SYSTEM	8105710	52740

## ADJUSTABLE TOW BAR

	<u>CAPACITY</u>	<u>MODEL</u>
2" COUPLER	5,000 LBS	74510

## MAGNETIC TOWING LIGHTS

	<u>MODEL</u>
INCLUDES 20' CABLE & 4-WAY PLUG	52000



PLEASE CALL FOR CURRENT PRICES





Hoop II



Super Hoop



## TRUCK BED LINERS

Tough, one-piece, seamless polyethylene construction, custom molded for your model and year of pickup. Available in over and under-the-rail styles. Complete with lifetime guarantee.



## TRUCK BED MAT

This heavy duty truck bed mat is the perfect accessory for any truck! The highest quality, thickest bedmat available to protect your truck bed from scratching and everyday abuse.



Tougher than your truck! For those who want the very best! Made of rugged marine carpet, bonded to waterproof foam. Won't scratch your paint and cargo won't slide. Impervious to gas, oil, grease, chemicals, and acids. Simply clean with hose, vacuum, brush, or compressed air.



## DO-IT-YOURSELF BRUSH-ON BEDLINER KIT

Save hundreds of dollars! Easy to apply, beautifies and protects bed surface, prevents rust, waterproofs, repairable. Won't chip, flake, or peel!

COMPLETE KIT: Kit includes one gallon of ready-to-use protective coating (enough for 6' bed), application brush, two rollers, on roller handle, prep pad.

QUART (coating only): Use quart to complete coverage on 8' bed or for repairs.



## TRUCK STEPS

Wide step with aggressive diamon non-slip tread area. Available in Polished, Titanium or Black. 10" HOOP II or 20" SUPER HOOP.



## BUG SHIELDS

A stylish, contoured, aerodynamic design to protect your hood and windshield from bugs, rocks, snow, and road debris.

# JACKRABBIT™ SPRING-ACTION RETRACTABLE TONNEAU COVER

Retracts out of the way into canister at the front of the truck bed.

Weather-resistant padded polymer laminated to rigid aluminum panels that glide along black powder-coated side rails. Heavy-duty spring helps the tonneau cover retract smoothly and easily. Built-in pull strap engages the latch at 12" intervals on short and long-bed models. No-drill, clamp-in design (in most applications) for quick and drill-free installation.



## RECOVERY WINCHES

CAPACITY	RETURN RATE	MODEL
6,000 LBS.	48.5 FT/MIN	M6000
8,000 LBS.	42 FT/MIN	M8000
9,000 LBS.	38 FT/MIN	XD9000



Model M6000

## WHEEL CHOCKS

Heavy duty no-slip wheel stops.

10" x 6" x 8"

MODEL  
WC1086



## INTERSTATE BATTERIES

High performance batteries available for cars, light duty trucks, heavy duty trucks, and lawn & garden equipment.

Most batteries available in one day.



## STROBE LIGHTS

FLASH	BRIGHTNESS CANDELA/SEC	VOLT	MODEL
SINGLE	150	12	769A
DUAL	300	12-48	769-1A
QUAD	400	12-48	769-2A
QUAD	1200	12-24	790A

### MAGNETIC

FLASH	BRIGHTNESS CANDELA/SEC	VOLT	MODEL
SINGLE	150	12	769MA
QUAD	400	12-48	769-2MA



PLEASE CALL FOR CURRENT PRICES

## BACK-UP ALARM

ALARM LEVEL	MODEL
97DECIBELS	780

## FREEDOM SAFES

Made by Liberty Safe, the #1 selling safe in America. Sizes ranging from 4 to 35 cu. ft., high gloss or textured finishes, and fire protection up to 1200°. Interior configuration on 17 CF models and larger can easily be changed to accommodate your needs.





Model 2000



Model 3000



Model 4001



Model 9001



Model 4003 SS

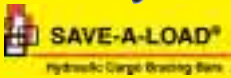

Hydraulic Cargo Bar



Model ACS10-PU

## ANCHORS & CLEATS

Installs in truck stake pockets, toolboxes, trailers, RV's boats, or on any flat surface.

CLEAT  
ANCHOR

MODEL  
2000  
3000

## BULL RINGS

Snaps up, snaps down. No drill installation. 1000 lbs. capacity.  
Stainless steel eye.

UNIVERSAL-BLACK  
UNIVERSAL-BLACK/STAINLESS STEEL  
TOYOTA TUNDRA-BLACK

MODEL  
4001  
4003 SS  
9001

## D-RINGS

1/2" - FOR CARRIAGE BOLTS  
5/8" - WITH WELD-ON BRACKET  
3/4" - WITH WELD-ON BRACKET  
1" X 5" X 6" - WELD-ON  
RECESSED TIE DOWN

MODEL  
53242  
53252  
53262  
53282  
53292

## TRUCK BED CARGO NET

Unique Zipcord® system easily adjusts length and tension on load.

ONE SIZE FITS ALL

MODEL  
06141

## SAVE-A-LOAD® EXPANDING CARGO BARS

40"-74"  
45"-75" HEAVY DUTY

MODEL  
19702  
ACS10-PU



Model  
156FR



Model ACS 142FR



Model 99FR  
(2 shown)

## LOADING RAMPS

CENTER FOLD  
Extends to 90"  
  
TRI-FOLD  
Great for loading 4 wheelers  
Extends to 69" x 46" x 1 1/4"  
  
EXPANDABLE  
Extends from 48" to 60" wide

CAPACITY  
1000 LBS  
  
1,500 LBS  
  
1,500 LBS  
  
MODEL  
99FR  
  
156FR  
  
142FR



## ANCHOR POINTS SETS OF TWO

TYPE	FINISH	MODEL
MINI CLEAT ROPE HOOK	ZINC	91500
FOLD-AWAY CLEAT	CHROME	812031
FOLD-AWAY CLEAT	BLACK	812032
HORSESHOE ROPE HOOK	CHROME	812033
T-ROPE HOOK	CHROME	91548



Model 91500



Model 91542



Model 91501



Model 91548



## QUICK RELEASE STRAP

SIZE	MODEL
1" x 6'	415400
1" x 12'	412600
6' - 4 PACK	412440



Model 412440



Model 415400



Model 325600



Model 350700

## RATCHET CARGO STRAP

SIZE	MODEL
1 1/8" x 16'	325600
1 1/2" x 16'	350701
2" x 27'	310081
4" x 27'	320800

## RACK-STRAP

### TRUCK RACK LOAD STRAPS

To secure any load to your rack.

DESCRIPTION	MODEL
FOR ROUND STYLE RACKS	RS-2
FOR SQUARE TUBE RACKS	RS-1

PLEASE  
CALL FOR  
CURRENT  
PRICES



**PETERSON**  
MANUFACTURING CO.

## SIDE MIRRORS REPLACEMENTS FOR CHEVY OR FORD TRUCKS

Chevy available in chrome finish.  
Ford available in chrome or black finish.

MODEL
CALIFORNIA MIRROR
5" SPOT MIRROR
8" SPOT MIRROR

667X
654X
608X

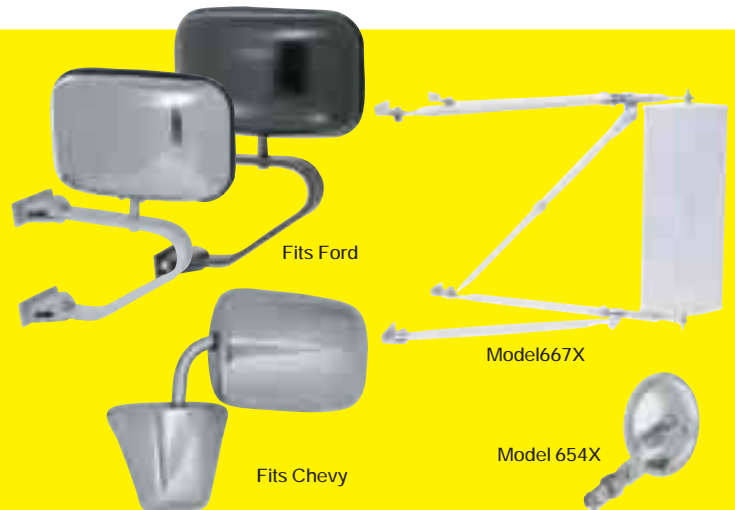

Fits Ford

Model667X

Fits Chevy

Model 654X



**DashMat**



**CUSTOM-MADE  
TO YOUR  
DIMENSIONS!**

**HUSKY LINERS**



**PrecisionFit**



**Saddlebags™**



## **ORIGINAL DASHMAT®**

The finest foam-backed velour & carpet dash covers. Custom fit for your vehicle. A great selection of colors to match your dash available. Custom orders in 10 days.

## **CAB ORGANIZER**

Includes handy storage pockets and rifle pouch. Easily installs behind all truck seats. Conceals items behind the seat to prevent theft and clean up dashboard clutter.

## **VINYL FLOOR MATS**

Replace old, worn, floor mats and save your carpet from the wear and tear of everyday driving. Dress up any vehicle. Available in a variety of colors and styles.

## **FRONT FLOOR MATS**

Custom made quality floor mats for a custom fit in any vehicle. Great for special applications.

## **TRUCK SEAT COVER**

A rugged saddle blanket with diamond tufted vinyl center panel. Has deep, sturdy pockets and vinyl scabbard. Machine washable. Easy to install.

## **CUSTOM SEAT COVERS**

Lifetime warranty on all Tailored Seat Covers for protection for as long as you own your vehicle. We use O.E.M. fabric for the whole seat. (No vinyl on back or sides)

## **TRUCK CONSOLE**

Padded vinyl arm rest, drink holders designed to hold multi-sized containers securely. Easy access storage tray, 12 no-rattle cassette storage holder. Available in a variety of colors.

**PLEASE CALL FOR CURRENT PRICES**

## ALUMINUM DRAWER STORAGE

### FLOOR MODEL

L	W	H	DRAWERS	MODEL
50"	12"	6"	1	1401980
50"	24"	6"	2	1402980
50"	36"	6"	3	1403980
50"	48"	6"	4	1404980

### STACKED MODEL

L	W	H	DRAWERS	MODEL
50"	12"	12"	2	1407980
50"	12"	18"	3	1408980
50"	12"	24"	4	1409980

## STORALL® STEEL DRAWER UNITS

### 48" LONG

W	H	COMPARTMENTS	DIVIDERS	MODEL
12"	9"	1	0	661980
24"	9"	2	1	662980
36"	9"	3	2	663980
48"	9"	4	3	664980
12"	13"	1	0	665980
24"	13"	2	1	666980
36"	13"	3	2	667980
48"	13"	4	3	668980

## HEAVY-DUTY CHESTS

L	W	H	MODEL	CU. FT.
42"	20"	23¾"	653990	9.3
48"	24"	27¾"	654990	15.4
60"	24"	27¾"	655990	19.3

## SLOPED-LID HEAVY-DUTY CHESTS

L	W	H	MODEL	CU. FT.
60"	30"	39½"	680990	32.7

## DROP-FRONT PIANO BOX

L	W	H	MODEL	CU. FT.
60"	30"	50"	683990	47.5
72"	30"	50"	684990	56.5

## FIELD OFFICE

L	W	H	MODEL	CU. FT.
63"	42"	80"	674990	100.0

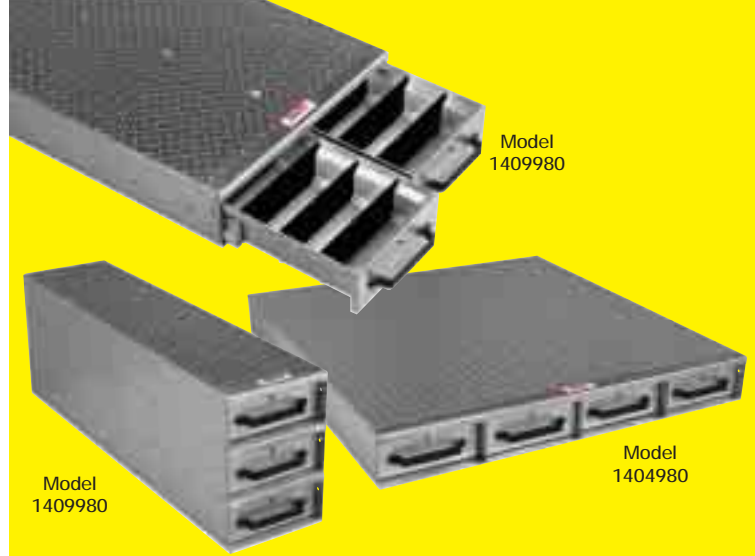



## PROVIDING THE BEST PROTECTION FOR YOUR TOOLS AND EQUIPMENT



Model 2472



Model 4842

### JOBMASTER® CHESTS

Watchman® IV lock system offers the strongest deadbolt style mechanism for ultimate security. 16 gauge steel body with fully arc welded seams for extra strength and weather protection. Recessed handles prevents damage during transportation. 12 gauge caster skids.

MODEL	DIMENSIONS	CU. FT.
MODEL 32	32" x 19" x 18 <sup>3</sup> / <sub>8</sub> "	5.0
MODEL 36	36" x 19" x 21 <sup>3</sup> / <sub>8</sub> "	7.0
MODEL 42	42" x 19" x 23 <sup>3</sup> / <sub>8</sub> "	9.0
MODEL 60	60" x 24" x 28 <sup>1</sup> / <sub>4</sub> "	20.25
MODEL 4824	48" x 24" x 28 <sup>1</sup> / <sub>4</sub> "	16.0
MODEL 4830	48" x 30" x 34 <sup>1</sup> / <sub>4</sub> "	25.25
MODEL 2472	72" x 24" x 28 <sup>1</sup> / <sub>8</sub> "	24.5



Model 2060



Model 3068

### CLASSIC STORAGE CHESTS

Lightweight storage chest provides security and protection at home or on the jobsite. Recessed lock housing protects padlock from bolt cutters. 16 gauge steel with fully arc welded seams. 12 gauge caster skids. Built-in tool tray.

MODEL	DIMENSIONS	CU. FT.
MODEL 2032	32" x 19" x 18 <sup>1</sup> / <sub>4</sub> "	5.0
MODEL 2048	48" x 24" x 28"	16.0
MODEL 2060	60" x 24" x 28"	20.0
MODEL 3068-Slant top	60" x 30" x 37"	31.0



Model 89



Model 69



Model 91

### STORAGEMASTER® CHESTS

The ultimate in jobsite security. Watchman® IV lock system. Recessed handles eliminates damage during transportation. Heavy duty 16 gauge steel with fully arc welded seams. Dual gas springs for one-handed easy opening. 12 gauge caster ready skids.

MODEL	DIMENSIONS	CU. FT.
MODEL 69	60" x 30" x 37"	35.3
MODEL 79	48" x 30" x 49"	38.2
MODEL 89	60" x 30" x 49"	47.8
MODEL 90	72" x 30" x 49"	57.5
MODEL 91 - built-in ramp	72" x 30" x 49"	57.5



Model 119

**PLEASE CALL FOR CURRENT PRICES**

### PORTABLE FIELD STATION

MODEL	DIMENSIONS	CU. FT.
MODEL 119	60" x 42" x 82"	115.2



**PROVIDING THE BEST PROTECTION  
FOR YOUR TOOLS AND EQUIPMENT**

**JOBMASTER® CABINETS**

Secure Watchman® IV deadbolt locking system. Recessed handles. Convenient foot latch easily opens doors. Adjustable or removable bottom shelf. Heavy duty 16 gauge steel with baked on enamel finish. 3" deep doors for extra storage.

**HALF WIDTH SHELF CABINETS**

MODEL	DIMENSIONS	CU. FT.
MODEL 111	60" x 24" x 60"	47.5
MODEL 112	60" x 30" x 60"	54.9

**FULL WIDTH SHELF CABINETS**

MODEL	DIMENSIONS	CU. FT.
MODEL 109	60" X 24" X 60"	47.5
MODEL 139	60" x 30" x 60"	59.4
MODEL 129	72" x 24" x 51"	48.0
MODEL 99*	60" x 30" x 60"	59.4

\*Also includes double door on back of cabinet for easy access.



Model 111



Model 112



Model 129



Model 100

**JOBMASTER® ROLLING CABINET**

MODEL	DIMENSIONS	CU. FT.
MODEL 100	60" x 30" x 65"	60.9

**JOBMASTER®  
ROLLING WORK BENCHES**

MODEL	DIMENSIONS
MODEL 40 - 2 drawers + full shelf	40 <sup>3</sup> / <sub>4</sub> " x 25" x 37 <sup>1</sup> / <sub>2</sub> "
MODEL 44 - 4 drawers + half shelf	40 <sup>3</sup> / <sub>4</sub> " x 25" x 37 <sup>1</sup> / <sub>2</sub> "



Model 44

**STORAGEMASTER®  
ROLLING WORK BENCHES**

MODEL	DIMENSIONS
MODEL 47	46 <sup>1</sup> / <sub>4</sub> " x 25" x 37 <sup>1</sup> / <sub>2</sub> "
MODEL 49 - 8 drawers + 1 shelf	46 <sup>1</sup> / <sub>4</sub> " x 25" x 37 <sup>1</sup> / <sub>2</sub> "



Model 47



Model 49

**WAR WAGON®  
ROLLING WORK BENCH**

MODEL	DIMENSIONS
MODEL 62	62" x 32" x 34"



Model 62



## MOSTER BOX® MAXIMUM SECURITY SERIES

Exclusive heavy-duty tubular steel frame. Four-point crane lift system. Integrated recessed lock. Exclusive non-linear three-point latching system. Power Pass® electrical pass-through grommet. Recessed handles.

Heavy-duty hinges.

MODEL	DIMENSIONS	CU. FT.
MODEL 1000 BOX	66" x 30" x 54½"	48.0
MODEL 1010 CHEST	66" x 30" x 36"	31.0
MODEL 1020 CABINET	66" x 30" x 54½"	52.0



## WALL CABINET

MODEL	DIMENSIONS	CU. FT.
MODEL 33	32" x 16" x 36"	10.7



Model 33

## PORTABLE WORK TABLE

MODEL	DIMENSIONS	LOAD
MODEL R-72	71½" x 27½" x 36"	750 LBS.



Model R-72

## HAND TOOL BOXES

### 18 GAUGE STEEL

Full length piano hinge. Durable powder coat finish. removable steel tray.

MODEL	DIMENSIONS	CU. FT.
MODEL 741	20" X 8" x 8"	.75
MODEL 742	22" x 9" x 9"	1.0
MODEL 743	26" x 11" x 9½"	1.5



Model 741, 742 & 743

### 16 GAUGE STEEL

Dual heavy duty handles. Hemmed edges for safety. Baked enamel finish.

MODEL	DIMENSIONS	CU. FT.
MODEL 28	28" x 12" x 12"	2.3
MODEL 30-WELDER'S BOX	30" x 16" x 12"	3.3



Model 28 & 30

## TRAYS

MODEL	DIMENSIONS
MODEL 10 Tote Tray	18" x 10" x 3¾"
MODEL 11 Tote Tray	18" x 10" x 3¾"
MODEL 21 TOOL TRAY	FITS #60, 4824, 2472 21⅝" x 8" x 4"
MODEL 31 TOOL TRAY	FITS #4830 27⅝" x 8" x 4"
MODEL 41 TOOL TRAY	FITS #32, 36, 42 16⅝" x 8" x 4"
MODEL 51 TOOL TRAY	FITS #28 27⅝" x 11" x 3"



Model 10



Model 11



Model 21

## CASTERS

DESCRIPTION	MODEL
4" SWIVEL WITH BRAKE / 4" RIGID	405/404
5" RIGID	505
6" SWIVEL WITH BRAKE / 6" RIGID	607/606



LARGE SELECTION OF MASTERLOCKS IN-STOCK





*Bill's* **ACE Truckbox Center**  
**TRUCKS, VANS & JOBSITES**

3550 Pacheco Blvd. • Martinez, CA 94553 • (925) 228-6136

**PROFESSIONAL  
 INSTALLATION  
 AVAILABLE!**

*...shop where  
 the pros shop*

This catalog is intended to show a sample of the vast amount of products we can provide you for your vehicle. Please confirm sizes, ratings and your requirements with our employees regarding manufacturer's specifications so that we ensure the products meet your specific needs.

**TOLL FREE (888) 379-0828**



©2009 Bill's Ace Truckbox



[www.acetruckbox.com](http://www.acetruckbox.com)